

Level Controls for Scrubbers

Model L1200 Float Operated Electric

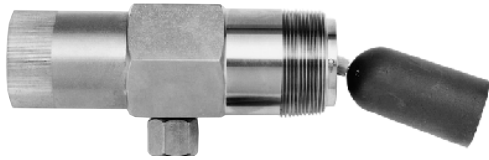

L1200 Series

Patents 3970099, 4505288, 4573489

- BUOYGLAS™ Float Operates to 0.5 Specific Gravity
- Stainless Steel Models Meet NACE Requirements and Carry Canadian Registration Numbers
- Models Rated for 2000 psi (13.8 MPa) [138 bar] Vessels
- Models Listed for Class I, Division 1 Locations

Model L1200N Float Operated Pneumatic

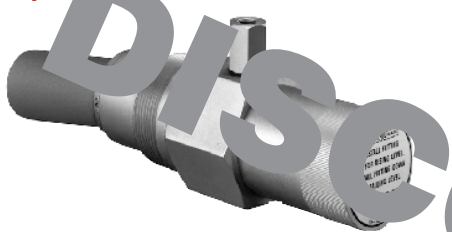

L1100 and L1200 Series Level Switches

These float operated level switches are available in electric and pneumatic models. They are primarily designed for high level applications but models are available for low level. Electric models are listed for Class I, Division 1, Groups C & D hazardous locations. Models are available in all stainless steel to NACE standard MR-01-75 for direct exposure to H₂S service. These level switches have screw-in connections for direct installation or an optional external float chamber is available for the L1200 series high pressure versions. The high pressure versions of both L1100 and L1200 series are rated for 2000 psi (13.8 MPa) [138 bar] operating pressure. See the specifications sections of this bulletin for further details.

Note: All stainless steel versions of L1100, L1200, L1200N, L1200NDVO, and L1200NDVOR carry Canadian Registration Number OF1476.2.

Model L1200NDVOR Float Operated Pneumatic with Dump Valve Operator, Pressure Regulator and Gage



Application: L1100 and L1200 Series

Designed primarily for gas compressor scrubber level. Low pressure models can be used anywhere level switching of a pressurized vessel is required. Electric models are typically used for high level switching of an engine or electric motor, while pneumatic models operate vessel dump valves such as our DV-series. Models designed for low level switching have been used for fuel tanks, hydraulic oil, etc.

DV Series Dump Valves

The DVU150, DVU175, DVU2105/2115/2120 are pneumatically controlled dump valves. These valves open and close automatically by pneumatic control from an L1200NDVO or similar dump valve operator. Diaphragm actuated, the DV series valves operate at 30-70 psi (207-483 kPa) [2.07-4.83 bar] with up to 2000 psi (13.7 MPa) [137 bar] vessel pressure. A pop up button indicates valve open/closed.

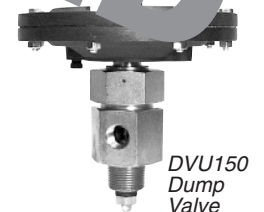

DVU150
 Dump
 Valve

Primarily engineered for compressor scrubbers, these valves can be applied to any liquids dumping job that is compatible with the valves materials, pressure limit and flow rates.

Model L1200NDVO Float Operated Pneumatic with Dump Valve Operator



Note:

The Murphy Series 1200 Liquid Level Switches are in the process of being replaced with the improved, more robust design of the Murphy LS200 Series Liquid Level Switches. The SLS (Scrubber Level System) which includes the high level switch, pneumatic level switch and DVU Dump valve will only be offered with the LS200 Series Switches, now available.

**Products covered by this bulletin comply with EMC Council directive 89/336/EEC regarding electromagnetic compatibility except as noted.



Specifications	L1100	L1111	L1200	L1200N	L1200NDVO	L1200NDVOR
Body						
• Standard: Electroless Nickel plated steel	× ^A	× ^A	× ^B	× ^B	× ^B	× ^B
• Optional: 316 Stainless Steel [†]	× ^A	× ^A	× ^B	× ^B	× ^B	× ^B
Pressure Rating						
• 15 psi (103 kPa) [1.03 bar] Polyethylene Float						
• 1500 psi (10.3 MPa) [103.42 bar] Stainless Float	×	×	×	×	×	×
• 2000 psi (13.8 MPa) [138 bar] BUOYGLAS™ Float	×	×	×	×	×	×
Temperature Rating						
• Standard: -20/175°F (-29/79°C)						
• Standard: -20/300°F (-29/149°C)	×	×	×	×	×	×
• Optional: -20/400°F (-29/204°C)*	×		×	×	×	×
Specific Gravity						
• Standard: 0.5 with BUOYGLAS™ float	×	×	×	×	×	×
• Optional: 0.65 with 304 Stainless Steel [†]	×		×	×	×	×
• Standard 0.73 Polyethylene Float						
Electrical						
• Standard SPDT: 5 A @ 125/480 VAC (see p. 3 for full ratings)	×	×	×			
• Optional DPDT: 10 A @ 250 VAC (see p. 3 for full ratings)	×	×	×			
Wire: 18 AWG x 36 in. (1.0 mm ² x 914 mm)	×	×	×			
O-Rings: Viton	×	×	×	×	×	×
Valve: Two-way snap-action vent type • 1/8 in. (3 mm) orifice w/Viton "A" seat • 1/8 NPT inlet; 1/4 NPT vent (bottom of body) • 30-70 psi (207-483 kPa) [2.07-4.83 bar] operating pressure				×	×	×
Dump Valve Operator: Operates Murphy DV Series dump valves or similar. 1/8 NPT inlet/outlet vent.					×	×
Pressure Regulator/Filter and Murphy 20BPG: 0-75 psi (0-517 kPa) [0-5.17 bar] pressure gauge. Maximum input 300 psi (2.07 MPa) [20.68 bar]. 1/8 NPT in/out.						×
Operation: H=For high level, L=For low level	H	L	H	H	H	H

^A=1-1/2 NPT

^B=2 NPT

[†]Meets NACE standard MR-01-75 for direct exposure to H₂S service.

*Not available with DPDT snap-switch.

The Murphy Gas Compressor Scrubber Level System (SLS)

The system provides for liquid control in gas scrubber applications, by dumping liquids to drain and protecting compressors with a high liquid level switch. Wetted metal parts are made to survive constant use in corrosive environments. *See Bulletin: SLS-04005B for more details.*

Filter/Regulator & MURPHYGAGE®

"Instrument Quality Air/Gas Supply"

Pneumatic Level Control
Float actuated level snap-acting switch controls pneumatic pressure to open and close dump valve.
LS200NDVOR: Dump Valve Operator, pressure regulator, and pressure indicating MURPHYGAGE.®

High Level Shutdown Switch
Stainless steel float actuated level switches to alarm and/or shutdown the equipment.
LS200: 2" NPT pipe connection; Rated 2000 psi (13.7MPa) [137bar]; Class I, Division 1. SPDT snap-switch standard. DPDT Optional.
All Stainless Steel available.

Control Panel

Pneumatic Dump Valves
See DVU-01069B for more details.

Two piece union design with manual valve operator allows soft plug and hard seat to be replaced without disassembling outlet piping or scrubber pipe connection. Diaphragm actuated valves operate on 30-70 psi (207-483 kPa; 2-5 bar).

Dimensions

L1100 and L1200

Note 1:

L1100: 1-1/2 NPT

L1200: 2 NPT

Note 2: 1-9/16 (40 mm)

SF option:

L1100: 1-1/2 (38 mm)

L1200: 1-3/4 (44 mm)

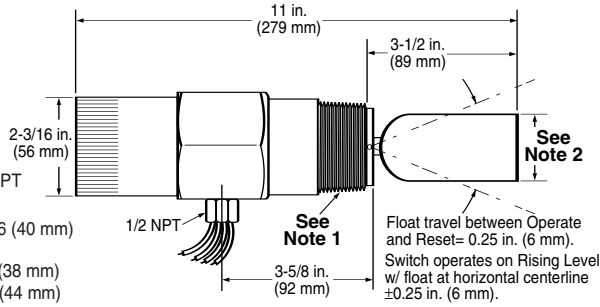

See Note 2
Float travel between Operate and Reset= 0.25 in. (6 mm).
Switch operates on Rising Level w/ float at horizontal centerline ±0.25 in. (6 mm).

L1111

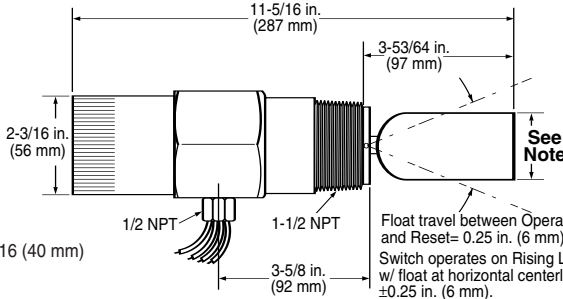

See Note
Float travel between Operate and Reset= 0.25 in. (6 mm).
Switch operates on Rising Level w/ float at horizontal centerline ±0.25 in. (6 mm).

Note: 1-9/16 (40 mm)

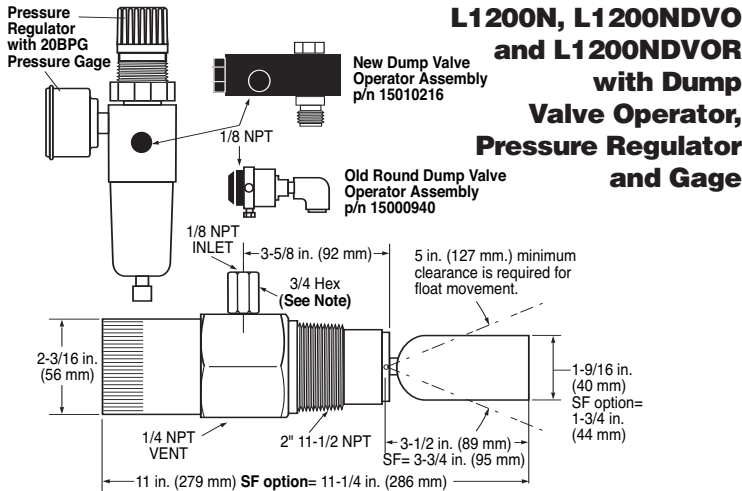

L1200N, L1200NDVO and L1200NDVOR with Dump Valve Operator, Pressure Regulator and Gage

Note: For use only with Old Round Dump Valve Operator Assembly (15000940).

Wiring

SPDT (snap-switch)

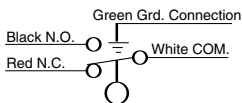

Switch Rating: 5 A @ 125-250- 480 VAC
1/2 A @ 125 VDC
1/4 A @ 250 VDC
2A @ 6-30 VDC Resistive
1A @ 6-30 VDC Inductive

DPDT (snap-switch)

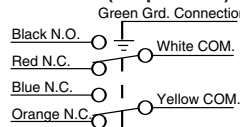

Switch Rating: 10 A @ 125-250 VAC
1/2 A @ 125 VDC
1/4 A @ 250 VDC
10 A @ 6-24 VDC Inductive/Resistive

Accessories

Adaptor Bushing 55050617 for DVU150 and DVU175

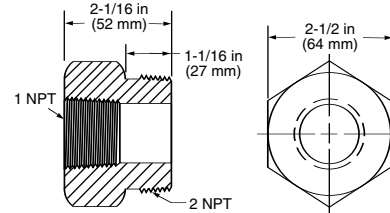

Material: 2-1/2 Hex bar stock C.R.S

Float Chamber 15051098

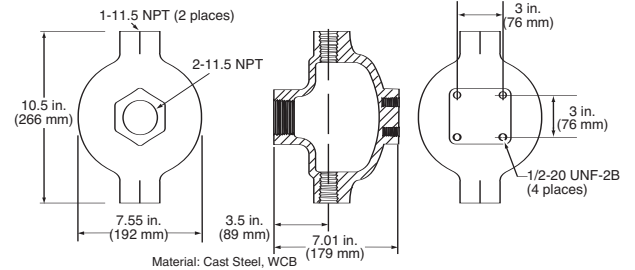

Material: Cast Steel, WCB

Operating Pressure: 2000 psi (13.8 MPa) [138 bar]
Operating Temperature: 400°F (204°C)

Typical L1200/L1200N Float Chamber Installation

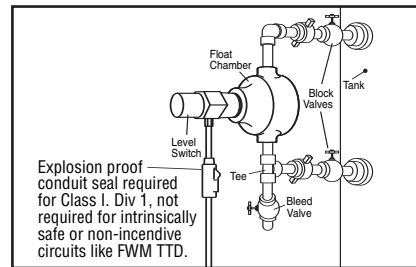

Weld Collar 15050375 (use with L1200 only, not for use w/L1200N)

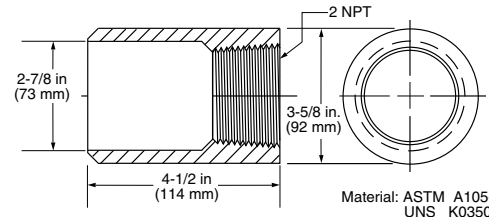

Typical L1200 Weld Collar Installation

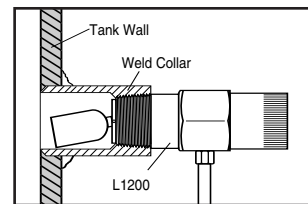

Operating Pressure:
2000 psi (13.8 MPa) [138 bar]
Operating Temperature:
400°F (204°C)

Float Shaft Extension 15000892

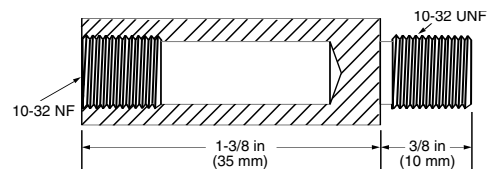

Material: AISI 304, UNS-S30400

NOTE: The extension is used with the L1100 and L1200 only. One extension is supplied with each unit. Use of additional extensions is not recommended as they reduce the ability of the unit to operate for the stated specific gravity.

How to Order

L1100 and L1200 Series

Build a complete model number using the diagram below. See example. See Specifications Chart on page 2 for standard and optional features.

Example model number

L1100 -

Options
D = DPDT
K = KALREZ Seals
SF = Stainless Steel Float
400 = 400°F (204°C) Service**

Base Models	
L1100*	L1100SS
L1111	L1111SS
L1200*	L1200SS*
L1200N*	L1200NSS*
L1200NDVO*	L1200NSSDVO*
L1200NDVOR*	L1200NSSDVOR*

*Stainless steel models carry Canadian Registration Number OF1476.2.

**Not available with DPDT snap-switch.

Note:

Refer to Bulletin **DVU-01069B** on the Murphy DVY Dump Valve and Bulletin **0600009** on the Series LS200 Level switches for SLS ordering and application information.

Accessories (order by part number designation)

15050375: Weld collar

15000892: Float shaft extension

55050617: DVU150/DVU175 adaptor bushing 2 NPT-M to 1 NPT-F

15051098: External Float Chamber

Replacement Parts (order by part number designation)

L1100/L1200

15000893: BUOYGLAS™ float

15000894: Stainless Steel float for L1200

15000937: Stainless Steel float for L1100

15000124: SPDT snap-switch assembly

15010213: L1100 counter balance assembly

15010214: L1200 counter balance assembly

L1200N

15050420: Cam spring return

15050421: Cam

15000893: BUOYGLAS™ float

15000894: Stainless steel float for L1200N

15050453: Valve stem

15010189: Counter balance assembly

L1200NDVO and L1200NDVOR

55050621: Regulator only

05706499: 20BPG-D-75 psi (0-517 kPa) [0-5.17 bar]

15010216: DVOA assembly (New rectangular style)

15000940: DVO assembly (Old round style)

00003341: Filter for regulator

00003340: Regulator diaphragm kit

Shipping Weights

L1100: 6 lb. (2.7 kg).

L1111: 5 lb. 11 oz. (2.5 kg).

L1200: 6 lb. 6 oz. (2.8 kg).

L1200N: 5 lb. 5 oz. (2.4 kg).

L1200NDVO: 5 lb. 14 oz. (2.6 kg).

L1200NDVOR: 6 lb. 10 oz. (3 kg).

SLS02: 19 lb. 6 oz. (8.7 kg).

Shipping Dimensions

L1100: 14 x 5 x 3-1/2 in. (356 x 127 x 89 mm).

L1111: 14 x 5 x 3-1/2 in. (356 x 127 x 89 mm).

L1200: 14 x 5 x 3-1/2 in. (356 x 127 x 89 mm).

L1200N: 14 x 5 x 3-1/2 in. (356 x 127 x 89 mm).

L1200NDVO: 14 x 5 x 3-1/2 in. (356 x 127 x 89 mm).

SLS02: 15 x 15 x 12 in. (381 x 381 x 305 mm).

Warranty

A limited warranty on materials and workmanship is given with this FWMurphy product.

A copy of the warranty may be viewed or printed by going to www.fwmurphy.com/warranty.asp.

Dump Valves Specify model number:

Model	Inlet	Outlet	Trim Size	Working Max. Press.
DVU2120	2 NPT	1 NPT	0.436 in. (11 mm)	2000 psi.
DVU2115	2 NPT	1 NPT	0.576 in. (15 mm)	1500 psi.
DVU2105	2 NPT	1 NPT	0.859 in. (22 mm)	500 psi.
DVU175	1 NPT	3/4 NPT	0.359 in. (9 mm)	1800 psi.
DVU175SS	1 NPT	3/4 NPT	0.359 in. (9 mm)	1800 psi.
DVU150	1 NPT	1/2 NPT	0.359 in. (9 mm)	1800 psi.
DVU150SS	1 NPT	1/2 NPT	0.359 in. (9 mm)	1800 psi.

FW MURPHY

P.O. Box 470248
Tulsa, Oklahoma 74147 USA
+1 918 317 4100 Fax: +1 918 317 4266
E-mail: sales@fwmurphy.com

INDUSTRIAL PANEL DIVISION

Fax: +1 918 317 4124
E-mail: ipdsales@fwmurphy.com

MURPHY POWER IGNITION

Web site: www.murphy-pi.com

CONTROL SYSTEMS & SERVICES DIVISION

P.O. Box 1819
Rosenberg, Texas 77471 USA
Phone: +1 281 633 4500 Fax: +1 281 633 4588
E-mail: sales@fwmurphy.com

FRANK W. MURPHY, LTD

Church Rd Laverstock
Salisbury SP1 1QZ UK
Phone: +44 172 241 0055 Fax: +44 172 241 0088
E-mail: sales@fwmurphy.co.uk
Web site: www.fwmurphy.co.uk

COMPUTRONIC CONTROLS, LTD

41 - 43 Railway Terrace
Nechells, Birmingham B7 5NG UK
Phone: +44 121 327 8500 Fax: +44 121 327 8501
E-mail: sales@computroniccontrols.com
Web site: www.computroniccontrols.com

www.fwmurphy.com

FW MURPHY INSTRUMENTS (HANGZHOU) CO. LTD

77 23rd Street
Hangzhou Economic & Technological Development Area
Hangzhou, Zhejiang 310018 China
Phone: +86 571 8788 6060 Fax: +86 571 8684 8878

FW MURPHY INTERNATIONAL TRADING (SHANGHAI) CO., LTD.

Suite 1704, Tower B, City Center of Shanghai; 100 Zunyi Road
Shanghai, 200051 China
Phone: +86 21 6237 2082 Fax: +86 21 6237 2083
Web site: mhong@fwmurphy.com



Printed in U.S.A.